User's Guide

HP 83485A/B
Optical/Electrical
Plug-In Module

HP part number: 83485-90056

Printed in USA June 1999

Notice. The information contained in this document is subject to change without notice. Hewlett-Packard makes no warranty of any kind with regard to this material, including but not limited to, the implied warranties of merchantability and fitness for a particular purpose. Hewlett-Packard shall not be liable for errors contained herein or for incidental or consequential damages in connection with the furnishing, performance, or use of this material.

Restricted Rights Legend. Use, duplication, or disclosure by the U.S. Government is subject to restrictions as set forth in subparagraph (c) (1) (ii) of the Rights in Technical Data and Computer Software clause at DFARS 252.227-7013 for DOD agencies, and subparagraphs (c) (1) and (c) (2) of the Commercial Computer Software Restricted Rights clause at FAR 52.227-19 for other agencies.

©Copyright Hewlett-Packard Company 1999
All Rights Reserved. Reproduction, adaptation, or translation without prior written permission is prohibited, except as allowed under the copyright laws.

Safety Symbols

The following safety symbols are used throughout this manual. Familiarize yourself with each of the symbols and its meaning before operating this instrument.

CAUTION

The *caution* sign denotes a hazard to the instrument. It calls attention to a procedure which, if not correctly performed or adhered to, could result in damage to or destruction of the instrument. Do not proceed beyond a *caution* sign until the indicated conditions are fully understood and met.

WARNING

The *warning* sign denotes a life-threatening hazard. It calls attention to a procedure which, if not correctly performed or adhered to, could result in injury or loss of life. Do not proceed beyond a *warning* sign until the indicated conditions are fully understood and met.

Instruction Manual

The **instruction manual** symbol. The product is marked with this symbol when it is necessary for the user to refer to the instructions in the manual.



General Safety Considerations

WARNING

Before this instrument is switched on, make sure it has been properly grounded through the protective conductor of the ac power cable to a socket outlet provided with protective earth contact.

Any interruption of the protective (grounding) conductor, inside or outside the instrument, or disconnection of the protective earth terminal can result in personal injury.

WARNING

There are many points in the instrument which can, if contacted, cause personal injury. Be extremely careful.

Any adjustments or service procedures that require operation of the instrument with protective covers removed should be performed only by trained service personnel.

WARNING

If this instrument is not used as specified, the protection provided by the equipment could be impaired. This instrument must be used in a normal condition (in which all means for protection are intact) only.

CAUTION

Before this instrument is switched on, make sure its primary power circuitry has been adapted to the voltage of the ac power source.

Failure to set the ac power input to the correct voltage could cause damage to the instrument when the ac power cable is plugged in.

CAUTION

Electrostatic discharge (ESD) on or near input connectors can damage circuits inside the instrument. Repair of damage due to misuse is *not* covered under warranty.

Before connecting any cable to the electrical input, momentarily short the center and outer conductors of the cable together. Personnel should be properly grounded, and should touch the frame of the instrument before touching any connector.

Assistance

Product maintenance agreements and other customer assistance agreements are available for Hewlett-Packard products.

For assistance, contact your nearest Hewlett-Packard Sales and Service Office.

Hewlett-Packard Sales and Service Offices

U.S. FIELD OPERATIONS		
Headquarters Hewlett-Packard Company 19320 Pruneridge Avenue Cupertino, CA 95014 U.S.A. 800 752-0900	California, Northern Hewlett-Packard Company 301 East Evelyn Mountain View, CA 94041 415 694-2000	California, Southern Hewlett-Packard Company 1421 South Manhattan Ave. Fullerton, CA 92631 714 999-6700
Colorado Hewlett-Packard Company 24 Inverness Place, East Englewood, CO 80112 303 649-5000	Georgia Hewlett-Packard Company 2000 South Park Place Atlanta, GA 30339 404 955-1500	Illinois Hewlett-Packard Company 5201 Tollview Drive Rolling Meadows, IL 60008 708 342-2000
New Jersey Hewlett-Packard Company 150 Green Pond Road Rockaway, NJ 07866 201 586-5400	Texas Hewlett-Packard Company 930 East Campbell Road Richardson, TX 75081 214 231-6101	
EUROPEAN FIELD OPERATIONS		
Headquarters Hewlett-Packard S.A. 150, Route du Nant-d'Avril 1217 Meyrin 2/Geneva Switzerland 41 22 780.8111	France Hewlett-Packard France 1 Avenue Du Canada Zone D'Activite De Courtaboeuf F-91947 Les Ulis Cedex France 33 1 69 82 60 60	Germany Hewlett-Packard GmbH Hewlett-Packard Strasse 61352 Bad Homburg Germany + 49 6172 16-0
Great Britain Hewlett-Packard Ltd. Eskdale Road, Winnersh Triangle Wokingham, Berkshire RG11 5DZ		

Hewlett-Packard Sales and Service Offices (continued)

INTERCON FIELD OPERATIONS		
Headquarters Hewlett-Packard Company 3495 Deer Creek Rd. Palo Alto, California 94304-1316 415 857-5027	Australia Hewlett-Packard Australia Ltd. 31-41 Joseph Street Blackburn, Victoria 3130 61 3 895-2895	Canada Hewlett-Packard Ltd. 17500 South Service Road Trans-Canada Highway Kirkland, Quebec H9J 2X8 Canada 514 697-4232
China China Hewlett-Packard Company 38 Bei San Huan X1 Road Shuang Yu Shu Hai Dian District Beijing, China 86 1 256-6888	Japan Yokogawa-Hewlett-Packard Ltd. 1-27-15 Yabe, Sagamihara Kanagawa 229, Japan 81 427 59-1311	Singapore Hewlett-Packard Singapore Ltd. Pte. Ltd. Alexandra P.O. Box 87 singapore 9115 65 271-9444
Taiwan Hewlett-Packard Taiwan 8th Floor, H-P Building 337 Fu Hsing North Road Taipei, Taiwan 886 2 712-0404		

Warranty

This Hewlett-Packard instrument product is warranted against defects in material and workmanship for a period of one year from date of shipment. During the warranty period, Hewlett-Packard Company will, at its option, either repair or replace products which prove to be defective.

For warranty service or repair, this product must be returned to a service facility designated by Hewlett-Packard. Buyer shall prepay shipping charges to Hewlett-Packard and Hewlett-Packard shall pay shipping charges to return the product to Buyer. However, Buyer shall pay all shipping charges, duties, and taxes for products returned to Hewlett-Packard from another country.

Hewlett-Packard warrants that its software and firmware designated by Hewlett-Packard for use with an instrument will execute its programming instructions when properly installed on that instrument. Hewlett-Packard does not warrant that the operation of the instrument, or software, or firmware will be uninterrupted or error-free.

LIMITATION OF WARRANTY

The foregoing warranty shall not apply to defects resulting from improper or inadequate maintenance by Buyer, Buyer-supplied software or interfacing, unauthorized modification or misuse, operation outside of the environmental specifications for the product, or improper site preparation or maintenance.

NO OTHER WARRANTY IS EXPRESSED OR IMPLIED. HEWLETT-PACKARD SPECIFICALLY DISCLAIMS THE IMPLIED WARRANTIES OF MERCHANTABILITY AND FITNESS FOR A PARTICULAR PURPOSE.

EXCLUSIVE REMEDIES

THE REMEDIES PROVIDED HEREIN ARE BUYER'S SOLE AND EXCLUSIVE REMEDIES. HEWLETT-PACKARD SHALL NOT BE LIABLE FOR ANY DIRECT, INDIRECT, SPECIAL, INCIDENTAL, OR CONSEQUENTIAL DAMAGES, WHETHER BASED ON CONTRACT, TORT, OR ANY OTHER LEGAL THEORY.

Contents

1. The Instrument at a Glance	
Ordering information	1-4
Menu and Key Conventions	1-6
The HP 83485A/B Optical/Electrical Plug-In Module	1-8
Front panel of the plug-in module	1-10
Getting the best performance	1-11
Installing the plug-in module	1-11
Trigger	1-12
Cleaning Connections for Accurate Measurements	1-13
To clean a non-lensed connector	1-15
To clean an adapter	1-16
To test insertion loss	1-16
To test return loss	1-17
2. Channel Setup Menu	
Displaying the Channel Setup menus	2-4
Display	2-5
Scale	2-6
Offset	2-7
Bandwidth/Wavelength	2-7
Channel autoscale	2-9
External scale	2-9
Calibrate	2-11
3. Calibration Overview	
Factory Calibrations	3-4
Mainframe Calibration	3-4
O/E Factory Wavelength Calibration	3-6
User Calibrations—Optical and Electrical	3-7
O/E User-Wavelength Calibration	3-9
Plug-in Module Vertical Calibration	3-11
Offset Zero Calibration	3-12
Dark Calibration	3-14
Channel Skew Calibration	3-15

Probe Calibration	3-16
External Scale	3-18
Complete Calibration Summary	3-20
4. Specifications and Regulatory Information	
Specifications	4-3
Vertical specifications	4-3
Environmental specifications	4-9
Characteristics	4-10
Trigger input characteristics	4-10
Declaration of Conformity	4-11
5. In Case of Difficulty	
If the mainframe does not operate	5-3
If the plug-in does not operate	5-4
Error Messages	5-6

Index

Figures

1-1. Front panel of the plug-in module.	1-10
2-1. Optical Channel Setup menu.	2-3
2-2. Electrical Channel Setup menu.	2-4
2-3. A typical Cal Status display.	2-13
3-1. Current Frame Δ Temp condition	3-5
3-2. Plug-in calibration menu	3-10
3-3. Offset Zero Calibration	3-13
3-4. Dark calibration menu	3-15
3-5. Electrical Channel Calibrate Menu	3-17
3-6. External Scale Menu	3-19

Tables

3-1. Factory Calibration Summary	3-4
3-2. Optical and Electrical Channel User Calibration Summary	3-8
3-3. Miscellaneous User Calibration Summary	3-9
3-4. Complete Calibration Summary	3-20

Contents

The Instrument at a
Glance

The Instrument at a Glance

What you'll find in this chapter

This chapter describes:

- options and accessories
- the key conventions used in this manual
- the front panel, rear panel and keys that do *not* display menus on the screen
- lightwave connector care

Understanding the information in this chapter will help you successfully operate the instrument.

CAUTION

The input circuits can be damaged by electrostatic discharge (ESD). Therefore, avoid applying static discharges to the front-panel input connectors. Before connecting any coaxial cable to the connectors, momentarily short the center and outer conductors of the cable together. Avoid touching the front-panel input connectors without first touching the frame of the instrument. Be sure that the instrument is properly earth-grounded to prevent buildup of static charge.

The HP 83485A optical/electrical plug-in module incorporates two measurement channels, one optical and one electrical. Each channel has two selectable bandwidth settings. In the lower bandwidth modes of 12.4 GHz, oscilloscope noise performance is excellent, while the 20 GHz mode allows greater fidelity for high speed signals.

The HP 83485B optical/electrical plug-in module incorporates a 30 GHz optical measurement channel and a 40 GHz electrical channel. The electrical channel also has a reduced-bandwidth setting of 18 GHz for improved noise performance.

The integrated optical channel reduces mismatch loss variation by eliminating signal distorting cables and connectors associated with the use of external receivers in order to accurately characterize optical waveforms. The optical

channel is calibrated at 1310 nm and 1550 nm to provide both accurate display of the received optical waveform in optical power units and measurement of the signal's average power. In addition, the User Cal feature provides for consistent accuracy at any wavelength between 1200 nm and 1600 nm using a source and power meter.

The HP 83485A optical/electrical plug-in module also is a calibrated SONET/SDH reference receiver that is measured to comply to ITU-TS (formerly CCITT) G.957 and Bellcore GR-253-CORE frequency response requirements for transmitter compliance testing. By either pressing a front-panel button or issuing an HP-IB command, a fourth-order Bessel-Thomson filter is inserted into or removed from the measurement channel by a very repeatable HP microwave switch. The switch removes the potential variability and the time wasted by manually inserting and removing the filter when alternating between high-fidelity waveform characterization and SONET/SDH compliance testing.

The HP 83485B optical/electrical plug-in module includes a reference receiver path, similar to the HP 83485A, for 10 Gb/s transmitter test. Although no industry standards exist for 10 Gb/s testing, the HP 83485B has been designed to meet anticipated future standards.

The electrical measurement channel may be used to perform measurements on tributary electrical signals, to evaluate receiver performance in transceiver testing, for measurements with HP's wide range of external optical receivers, or for general purpose measurements.

The HP 83485A optical/electrical plug-in module provides:

- 12.4 GHz and 20 GHz optical channel
- 12.4 GHz and 20 GHz electrical channel
- Switchable SDH/SONET filter for transceiver compliance testing
- Trigger channel input to the mainframe

The HP 83485B optical/electrical plug-in module provides:

- 30 GHz optical channel
- 18 GHz and 40 GHz electrical channel
- Switchable SDH/SONET filter for transceiver performance testing
- Trigger channel input to the mainframe

Ordering information

HP 83485A options

Option 030 Built-in STM-1/OC-3 155 Mb/s SDH/SONET reference receiver
Option 032 Built-in STM-4/OC-12 622 Mb/s SDH/SONET reference receiver
Option 034 Built-in STM-16/OC-48 2.488 Gb/s SDH/SONET reference receiver
Option 0BW *HP 83485A/B Service Guide*
Option 0B1 Additional set of user documentation
Option 0B0 Deletes the user documentation
Option UK6 Measured performance data

HP 83485B options

Option 001 Latest operating system firmware for the HP 83480A mainframe
Option 002 Latest operating system firmware for the HP 54750A mainframe
Option 040 Fourth order filter/10 Gb/s reference receiver
Option 050 Fifth order filter/10 Gb/s reference receiver

Optical connector interface options

Option 011 Diamond HMS-10/HP
Option 012 FC/PC
Option 013 DIN 47256
Option 014 ST
Option 015 Biconic
Option 017 SC

Optional accessories

HP 54006A 6 GHz divider probe
HP 54008A 22 ns delay line
HP 54118A 500 MHz to 18 GHz trigger
HP 10086A ECL terminator
SMA (f-f) adapter, HP part number 1250-1158
SMA 50 Ω termination, HP part number 1810-0118, 1 each
APC 3.5 (f-f) adapter, HP part number 1250-1749
APC 2.4 (f-f) adapter, HP 11900B
APC 2.4 to 3.5 (f-f) adapter, HP 11901B
HP 81000AI Diamond HMS-10/HP connector interface
HP 81000FI FC/PC/SPC/APC connector interface
HP 81000KI SC connector interface
HP 81000SI DIN 47256/4108.6 connector interface
HP 81000VI ST connector interface
HP 81000WI Biconic

Menu and Key Conventions

The keys labeled Trigger, Disk, and Run are all examples of front-panel keys. Pressing some front-panel keys accesses menus of functions that are displayed along the right side of the display screen. These menus are called softkey menus.

Softkey menus list functions other than those accessed directly by the front-panel keys. To activate a function on the softkey menu, press the unlabeled key immediately next to the annotation on the screen. The unlabeled keys next to the annotation on the display are called softkeys.

Additional functions are listed in blue type above and below some of the front-panel keys. These functions are called shifted functions. To activate a shifted function, press the blue front-panel Shift key and the front-panel key next to the desired function.

Throughout this manual front-panel keys are indicated by a box around the key label, for example, **Timebase**. Softkeys are indicated by shading on the key label, for example, **Mask Align**. The softkeys displayed depend on the front-panel key pressed and which menu is selected. Shifted functions are indicated by the front-panel **Shift** key followed by the shaded shifted function, for example the Local function (above the **Stop/Single** front-panel key) will be shown as **Shift**, **Local**.

A softkey with On and Off in its label can be used to turn the softkey's function on or off. To turn the function on, press the softkey so On is highlighted. To turn the function off, press the softkey so Off is highlighted. An On or Off softkey function will be indicated throughout this manual as: **Test On**.

A softkey such as **Sweep Triggered Freerun** offers you a choice of functions. In this case you could choose Triggered by pressing the softkey until Triggered is highlighted, or choose Freerun by pressing the softkey until Freerun is highlighted. A choices softkey will be indicated throughout this manual as: **Sweep Triggered Freerun Triggered**.

When some softkeys, such as **Calibrate probe**, are pressed the first time, a measurement will be made and the result will be provided. Some softkeys, such as **Offset** require the entry of a numeric value. To enter or change the

value, use the general purpose knob located below the front-panel Measure section.

The HP 83485A/B Optical/Electrical Plug-In Module

The HP 83485A/B optical/electrical plug-in modules are two of several plug-in modules available for the HP 83480A, 54750A mainframes. Their main features are:

- Integrated, calibrated optical channel.
- Optical channel includes switchable SONET/SDH filter.
- Electrical measurement channel.
- 2.5 GHz trigger channel.
- Both optical and electrical measurement channels have user selectable bandwidths of 12.4 or 20 GHz. (*HP 83485A only*)
- 30 GHz optical channel bandwidth and user selectable 18 or 40 GHz electrical channel bandwidth. (*HP 83485B only*)
- 3.5 mm (m) connectors on electrical measurement channel and trigger channel. (*2.4 mm (m) connector on electrical channel of HP 83485B.*)
- One probe power connector.
- One auxiliary power connector.
- Optical channel has an HP universal adapter for 9/125 μm single-mode fiber input.

NOTE

If you wish to use the HP 83485A/B optical plug-in module in an HP 54750A digitizing oscilloscope, a firmware upgrade must first be installed. Order the HP 83480K communications firmware kit and follow the installation instructions.

The purpose of the plug-in module is to provide measurement channels, including sampling, for the mainframe. The plug-in module scales the input signal, sets the bandwidth of the system, and allows the offset to be adjusted so the signal can be viewed. The output of the plug-in module is an analog signal that is applied to the ADCs on the acquisition boards inside the mainframe. The plug-in module also provides a trigger signal input to the time base/trigger board inside the mainframe.

Front panel of the plug-in module

The plug-in module takes up two of the four mainframe slots. The optical channel provides calibrated measurement of optical waveforms in power units. Bandwidths are selectable on both channels to optimize sensitivity and bandwidth. The front panel of the plug-in module has two channel inputs and an external trigger input. The front panel also has two **Probe Power** connectors for HP 54700-series probes, **Aux Power** connector for general purpose use, and a key for each channel that displays the softkey menu. The softkey menu allows you to access the channel setup features of the plug-in module.

The front-panel **Probe Power** connectors allow automatic channel scaling and probe calibration with HP 54700 series probes. The front-panel **Aux Power** connector provides only power to HP 54700 series probes for use as a trigger input. Probe calibration and scaling are not required for a trigger input.

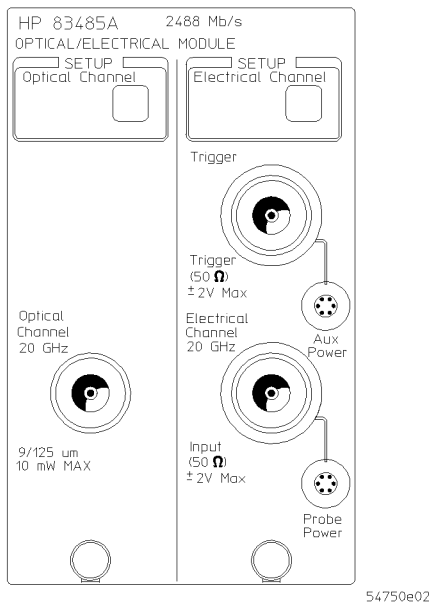

Figure 1-1. Front panel of the plug-in module.

Getting the best performance

To ensure you obtain the specified accuracy, you must perform a plug-in module vertical calibration. The calibration must also be performed when you move a plug-in module from one slot to another, or from one mainframe to another. Refer to Chapter 3 for information on performing a plug-in module vertical calibration.

Installing the plug-in module

You do not need to turn off the mainframe to install or remove the plug-in modules.

NOTE

If you wish to use the HP 83485A/B optical plug-in module in an HP 54750A digitizing oscilloscope, a firmware upgrade must first be installed. Order the HP 83480K communications firmware kit and follow the installation instructions.

The HP 83485A/B Optical/Electrical Plug-In Module

To use the plug-in module, the HP 83480A/54750A firmware revision 3.0 or higher is required.

The plug-in module can be installed in slots 1 and 2 or 3 and 4 on the HP 83480A, 54750A mainframe. The plug-in module will *not* function if it is installed in slots 2 and 3.

To make sure the analyzer meets all of the published specifications, there must be a good ground connection from the plug-in module to the mainframe. The RF connectors on the rear of the plug-in module are spring loaded, so finger-tighten the knurled screw on the front panel of the plug-in module to make sure the plug-in is securely seated in the mainframe.

CAUTION

Do not use extender cables to operate the plug-in module outside of the mainframe. The plug-in module using extender cables can be damaged by improper grounding when using extender cables.

Trigger

The external trigger level range for this plug-in module is ± 1 V. The trigger source selection follows the slots the plug-in module is installed in. For example, if the plug-in module is installed in slots 1 and 2, then the trigger source is listed as trigger 2. If it is installed in slots 3 and 4, then the trigger source is listed as trigger 4.

CAUTION

The maximum safe input voltage is ± 2 V + peak ac (+16 dBm).

CAUTION

The input circuits can be damaged by electrostatic discharge (ESD). Therefore, avoid applying static discharges to the front-panel input connectors. Before connecting any coaxial cable to the connectors, momentarily short the center and outer conductors of the cable together. Avoid touching the front-panel input connectors without first touching the frame of the instrument. Be sure that the instrument is properly earth-grounded to prevent buildup of static charge.

Cleaning Connections for Accurate Measurements

Accurate and repeatable measurements require clean connections. Use the following guidelines to achieve the best possible performance when making measurements on a fiber-optic system:

- Keep connectors covered when not in use.
- Use dry connections whenever possible.
- Use the cleaning methods described in this section.
- Use care in handling all fiber-optic connectors.
- When inserting a fiber-optic connector into a front-panel adapter, make sure that the fiber end does not touch the outside of the mating connector or adapter.

Because of the small size of cores used in optical fibers, care must be used to ensure good connections. Poor connections result from core misalignment, air gaps, damaged fiber ends, contamination, and improper use and removal of index-matching compounds.

Use dry connections. Dry connectors are easier to clean and to keep clean. Dry connections can be used with physically contacting connectors (for example, Diamond HMS-10/HP, FC/PC, DIN, and ST). If a dry connection has 40 dB return loss or better, making a wet connection will probably not improve (and can degrade) performance.

CAUTION

Hewlett-Packard strongly recommends that index matching compounds NOT be applied to their instruments and accessories. Some compounds, such as gels, may be difficult to remove and can contain damaging particulates. If you think the use of such compounds is necessary, refer to the compound manufacturer for information on application and cleaning procedures.

Cleaning Accessories

Item	HP Part Number
Isopropyl alcohol	8500-5344
Cotton swabs	8520-0023
Small foam swabs	9300-1223
Compressed dust remover (non-residue)	8500-5262

Cleaning Connections for Accurate Measurements**Dust Caps Provided with Lightwave Instruments**

Item	HP Part Number
Laser shutter cap	08145-64521
FC/PC dust cap	08154-44102
Biconic dust cap	08154-44105
DIN dust cap	5040-9364
HMS10/HP dust cap	5040-9361
ST dust cap	5040-9366

Inspecting Fiber-Optic Cables

Consistent measurements with your lightwave equipment are a good indication that you have good connections. However, you may wish to know the insertion loss and/or return loss of your lightwave cables or accessories. If you test your cables and accessories for insertion loss and return loss upon receipt, and retain the measured data for comparison, you will be able to tell in the future if any degradation has occurred.

Connector (or insertion) loss is one important performance characteristic of a lightwave connector. Typical values are less than 1 dB of loss, and sometimes as little as 0.1 dB of loss with high performance connectors. Return loss is another important factor. It is a measure of reflection: the less reflection the better (the larger the return loss, the smaller the reflection). The best physically contacting connectors have return losses better than 50 dB, although 30 to 40 dB is more common.

You can visually inspect your cables

Although it is not necessary, visual inspection of fiber ends can be helpful. Contamination or imperfections on the cable end face can be detected as well as cracks or chips in the fiber itself. Use a microscope (100X to 200X magnification) to inspect the entire end face for contamination, raised metal, or dents in the metal as well as any other imperfections. Inspect the fiber for cracks and chips. Visible imperfections not touching the fiber core may not affect performance (unless the imperfections keep the fibers from contacting).

To clean a non-lensed connector

CAUTION

Do not use any type of foam swab to clean optical fiber ends. Foam swabs can leave filmy deposits on fiber ends that can degrade performance.

1. Apply isopropyl alcohol to a clean lint-free cotton swab or lens paper.
Cotton swabs can be used as long as no cotton fibers remain on the fiber end after cleaning.
2. Before cleaning the fiber end, clean the ferrules and other parts of the connector.
3. Apply isopropyl alcohol to a new clean lint-free cotton swab or lens paper.
4. Clean the fiber end with the swab or lens paper. Move the swab or lens paper back and forth across the fiber end several times.

Some amount of wiping or mild scrubbing of the fiber end can help remove particles when application of alcohol alone will not remove them. This technique can remove or displace particles smaller than one micron.

5. Immediately dry the fiber end with a clean, dry, lint-free cotton swab or lens paper.
6. Blow across the connector end face from a distance of 6 to 8 inches using filtered, dry, compressed air. Aim the compressed gas at a shallow angle to the fiber end face.

Nitrogen gas or compressed dust remover can also be used.

CAUTION

Do not shake, tip, or invert compressed air canisters, because this releases particles in the can into the air. Refer to instructions provided on the compressed air canister.

7. As soon as the connector is dry, connect or cover it for later use.

To clean an adapter

1. Apply isopropyl alcohol to a clean foam swab.

Cotton swabs can be used as long as no cotton fibers remain after cleaning. The foam swabs listed in this section's introduction are small enough to fit into adapters.

Although foam swabs can leave filmy deposits, these deposits are very thin, and the risk of other contamination buildup on the inside of adapters greatly outweighs the risk of contamination by foam swabs.

2. Clean the adapter with the foam swab.
3. Dry the inside of the adapter with a clean, dry, foam swab.
4. Blow through the adapter using filtered, dry, compressed air.

Nitrogen gas or compressed dust remover can also be used.

CAUTION

Do not shake, tip, or invert compressed air canisters, because this releases particles in the can into the air. Refer to instructions provided on the compressed air canister.

To test insertion loss

Use an appropriate lightwave source and a compatible lightwave receiver to test insertion loss. Examples of test equipment configurations include the following equipment:

- HP 71450A or 71451A optical spectrum analyzers with Option 002 built-in white light source
- HP 8702 or 8703 lightwave component analyzer system
- HP 83420 lightwave test set with an HP 8510 network analyzer
- HP 8153 lightwave multimeter with a source and power sensor module

To test return loss

Use an appropriate lightwave source, a lightwave receiver, and lightwave coupler to test return loss. Examples of test equipment configurations include the following equipment:

- HP 8703 lightwave component analyzer
- HP 8702 analyzer with the appropriate source, receiver, and lightwave coupler
- HP 8504 precision reflectometer
- HP 8153 lightwave multimeter with a source and power sensor module in conjunction with a lightwave coupler
- HP 81554SM dual source and HP 81534A return loss module

The Instrument at a Glance



Channel Setup Menu

Channel Setup Menu

What you'll find in this chapter

This chapter describes the Channel Setup menu. A key tree and description of the available functions is included.

CAUTION

The input circuits can be damaged by electrostatic discharge (ESD). Therefore, avoid applying static discharges to the front-panel input connectors. Before connecting any coaxial cable to the connectors, momentarily short the center and outer conductors of the cable together. Avoid touching the front-panel input connectors without first touching the frame of the instrument. Be sure that the instrument is properly earth-grounded to prevent buildup of static charge.

At the top of the plug-in module are the **Channel** keys. These keys give you access to the Channel Setup menu for each input. The Channel Setup menu is displayed on the right side of the screen when the **Channel** key is pressed. There are several types of softkeys available. A description of the different softkeys and their functions is provided in the *HP 83480A, 54750A User's Quick Start Guide* supplied with the mainframe.

NOTE

The plug-in module has both an electrical channel and an optical channel. Although many of the softkeys are similar, some differences exist. The examples in this book use the optical channel and note when the user would see differences if using the electrical channel.

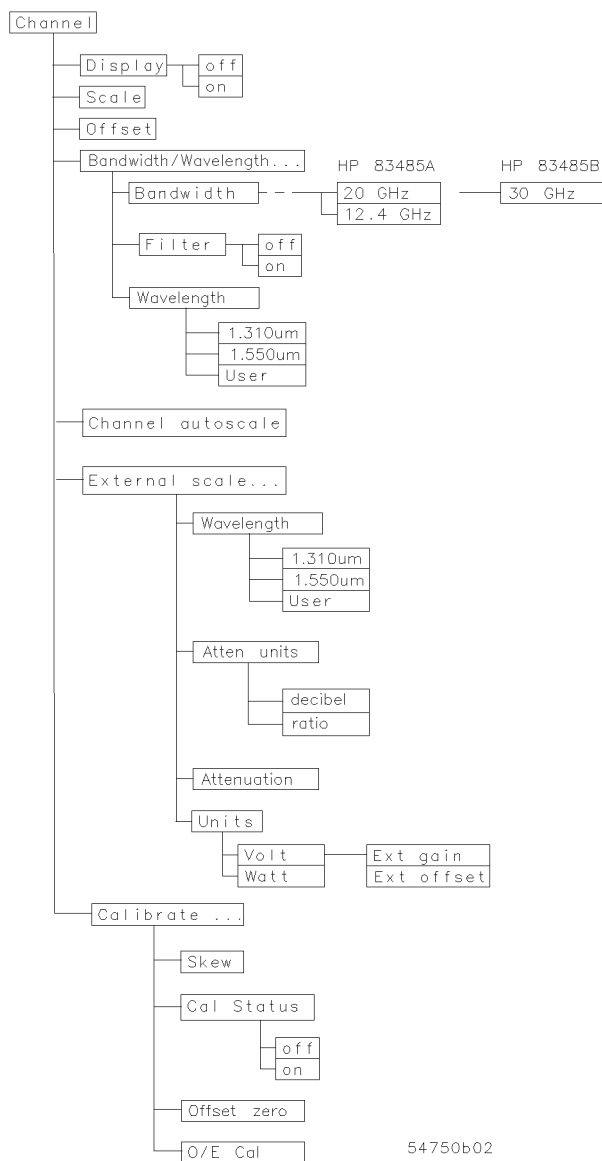

54750b02

Figure 2-1. Optical Channel Setup menu.

Channel Setup Menu

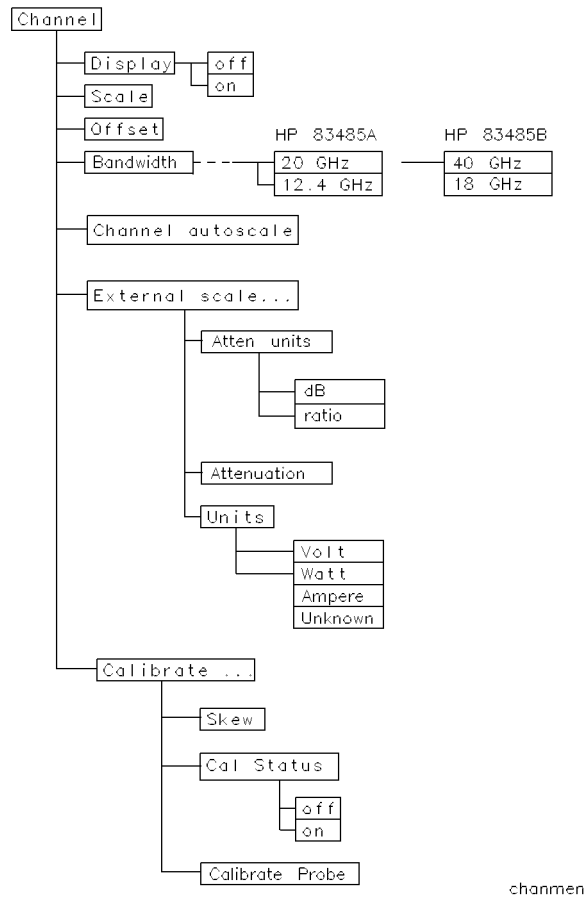

Figure 2-2. Electrical Channel Setup menu.

Displaying the Channel Setup menus

To display the optical Channel Setup menu, press the optical **Channel** key.

To display the electrical Channel Setup menu, press the electrical **Channel** key.

Display

The Display function turns the channel display off and on. When the channel display is on, a waveform is displayed for that channel, unless the offset is adjusted so the waveform is clipped off of the display.

The channel number, vertical scaling, and offset are displayed at the bottom left of the waveform area. They remain on the display until the channel is turned off, or an automatic measurement is performed. The automatic measurement results share the same area of the display as the channel setups.

When the channel display is off, the waveform display for that channel is turned off, pulse parameter measurements are stopped and acquisition on that channel is stopped, unless it is needed as an operand for waveform math functions.

Even though the channel display is off, you can still use the plug-in as a trigger source or as a function source in the Math menu. However, the analyzer will not trigger unless one or more of the other channel displays are turned on, or unless a math function is using one of the channels.

Key Path

Channel Display

Scale

The Scale softkey controls the vertical scaling of the waveform. If the fine mode is off, then the knob and arrow keys change the vertical scaling in a 1-2-5 sequence. When fine mode is on, the knob and arrow keys change the vertical scaling in 1 mV increments. You can also use the keypad to enter values in 1 mV increments, independent of the fine mode selection.

The units the scale is displayed in depend on the unit of measure selected with the Units softkey. The choices for units are volts or watts. (Amperes, or unknown are available on electrical channels only.)

Key Path

Channel Scale

Offset

The Offset softkey moves the waveform vertically. It is similar to the position control on analog oscilloscopes. The advantage of digital offset is that it is calibrated. The offset voltage for electrical channels is the voltage at the center of the graticule area, and the range of offset is ± 12 times the full resolution channel scale. For optical channels, the offset wattage is the wattage two graticule divisions above the bottom of the screen. This is set because, unlike voltage displays, “negative” power levels do not exist but the zero power level can be viewed clearly when the offset is set to zero watts. You can use the knob, arrow keys, or keypad to change the offset setting. The fine mode also works with offset.

When an HP 54700-series active probe is used with the plug-in module and is connected to the probe power connector adjacent to the channel input, the offset control adjusts the external scale factor and offset of the hybrid inside the active probe. A probe connected to the auxiliary power connector adjacent to the trigger input will function, but the channel scale factor will not be adjusted automatically.

The optical channel displays the value in watts and the electrical channel displays the value in volts.

Key Path

Channel Offset

Bandwidth/Wavelength. . .

You can use the **Bandwidth/Wavelength. . .** softkey to change the bandwidth and wavelength settings and turn the filter on and off on the optical channel.

Channel Setup Menu

Bandwidth

HP 83485A: This function is available on the electrical channel and on the optical channel only when the filter is switched off.

You can use the Bandwidth function to select either the 12.4 GHz or the 20 GHz bandwidth.

HP 83485B: This function is available on the electrical channel only.

You can use the Bandwidth function to select either the 18 GHz or 40 GHz bandwidth.

Key Path

Channel Bandwidth/Wavelength. . . Bandwidth

Filter On Off

The Filter function allows a SONET/SDH Bessel-Thomson filter to be switched into the channel to create a SONET/SDH reference receiver.

HP 83485A: Option 030 is 155 Mb/s STM-1/OC-3. Option 32 is 622 Mb/s STM-4/OC-12. Option 34 is 2.488 Gb/s STM-16/OC-48.

HP 83485B: Option 40 is 10 Gb/s fourth-order filter. Option 050 is 10 Gb/s fifth-order filter.

Key Path

Channel Bandwidth/Wavelength. . . Filter On Off

Wavelength

This function is only available on the optical channel.

The Wavelength function selects the desired wavelength for calibrated measurements. Factory calibrated wavelengths are 1310 nm and 1550 nm. A user-calibrated wavelength is also available and can be calibrated in the range from 1000 nm to 1600 nm. Refer to Chapter 3 for additional information on performing a calibration.

Key Path

Channel Bandwidth/Wavelength. . . Wavelength

Channel autoscale

The Channel Autoscale function provides a convenient and fast method for determining the standard vertical scale setting with the highest resolution that will not clip the waveform. Timebase and trigger settings are not affected.

This function is useful in manufacturing environments where the timebase and trigger settings remain constant and only the vertical scale needs to be adjusted for signal level variations in multiple DUTs.

Key Path

Channel Channel autoscale

External scale . . .

The External Scale function allows you to setup the analyzer to use external optical-to-electrical converters or attenuators. Scaling is automatically adjusted to account for the external device.

Key Path

Channel External scale . . .

Atten units

The Atten Units function lets you select how you want the probe attenuation factor represented. The choices are either decibel or ratio. The formula for calculating decibels is:

$$20 \log \frac{V_{out}}{V_{in}} \text{ or } 10 \log \frac{P_{out}}{P_{in}}$$

Attenuation

The Attenuation function lets you select an attenuation that matches the device connected to the analyzer. When the attenuation is set correctly, the analyzer maintains the current scale factors if possible. All marker values and voltage or wattage measurements will reflect the actual signal at the input to the external device.

The attenuation range is from 0.0001:1 to 1,000,000:1. When you connect a compatible active probe to the probe power connector, adjacent to the channel input, the instrument automatically sets the attenuation. For all other devices, set the probe attenuation with the knob, arrow keys, or keypad.

NOTE

Refer to Chapter 3 for information on calibrating to the tip of the probe.

Key Path

Channel External scale . . . Attenuation

Units

The Units function lets you select the unit of measure appended to the channel scale, offset, trigger level, and vertical measurement values. For the optical channel these units are Volts or Watts. For the electrical channel the units are Volts, Amperes, Watts, or unknown. Use Volt for voltage probes, Ampere for current probes, Watt for optical-to-electrical (O/E) converters, and unknown when there is no unit of measure or when the unit of measure is not one of the available choices.

Key Path

Channel External scale . . . Units

Ext gain and Ext offset

When you select Ampere, Watt, or unknown on an electrical channel or Voltage on an optical channel, two additional functions become available: External Gain and External Offset. These two additional functions allow you to compensate for the actual characteristics of the probe rather than its ideal characteristics. For example, you might have an amplified lightwave converter with ideal characteristics of 300 V/W with 0 V offset. But, its actual characteristics are 324 V/W with 1 mV of output offset. Therefore, set the External Gain to 324 V/W and the External Offset to 1 mV.

Key Path

Channel External scale . . . Units Volt Ext gain or
Ext Offset

Channel External scale . . . Units Watt Ext gain or
Ext Offset

Channel External scale . . . Units Unknown Ext gain or
Ext Offset

Calibrate

The calibrate menu allows you to null out any skew between probes or cables, remove the effects of offsets in the internal O/E converter, recalibrate the responsivity of the O/E converter, and check the present calibration status of the analyzer.

Key Path

Channel Calibrate

Skew

The Skew function changes the horizontal position of a waveform on the display. The Skew function has a range of $\approx +100 \mu\text{s}$. You can use skew to compensate for differences in cable or probe lengths. It also allows you to place the triggered edge at the center of the display when you are using a power splitter connected between the channel and trigger inputs. Another use for skew is when you are comparing two waveforms that have a timing difference between them. If you are more interested in comparing the shapes of two waveforms rather than the actual timing difference between them, you can use Skew to overlay one waveform on top of the other waveform.

To skew two channels

1. Turn both channels on and overlay the signals vertically.
2. Expand the time base so the rising edges are about a 45 degree angle.
3. Adjust the skew on one of channels so that the rising edges overlap at the 50 percent points.

Key Path

Channel Calibrate Skew

Cal status

The Cal Status function displays a screen similar to Figure 2-3.

Key Path

Channel **Calibrate** **Cal Status**

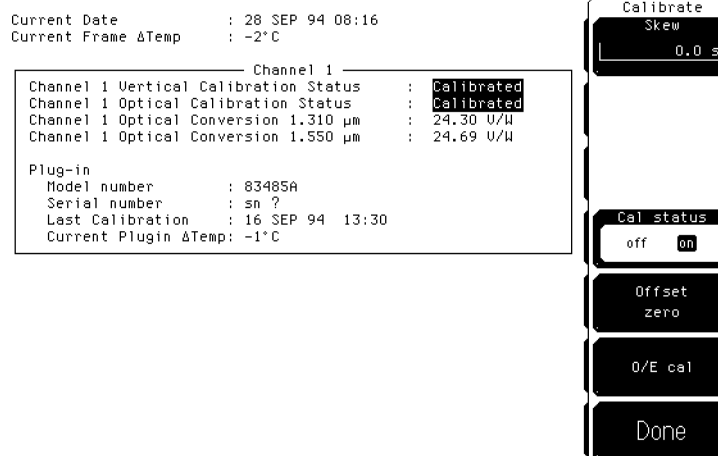

Figure 2-3. A typical Cal Status display.

Current Date

This is the current date and time. You can compare this to the last plug-in module calibration time. That way you will know how long it has been since the last plug-in module calibration was performed.

Current Frame ΔTemp

This is the temperature change on the inside of the instrument since the last mainframe calibration was performed. A positive number indicates how many degrees warmer the mainframe is currently as compared to the temperature of the mainframe at the last mainframe calibration.

Channel Setup Menu

Channel 1 Calibration Status

The instrument displays **Calibrated** or **Uncalibrated**, depending on whether the last plug-in module calibration is still valid. A calibration can be invalidated if:

- The mainframe has cycled power.
- The plug-in has been repaired, reprogrammed, or removed from the mainframe.
- The instrument's operating temperature has changed and remains more than 5°C from the temperature at which the Plug-in calibration was performed.

Uncalibrated indicates the plug-in module vertical calibration is invalid.

Plug-in

The Plug-in function lists the model number, serial number, date, time, and temperature delta. The temperature Δ is the temperature change from the temperature of the mainframe when the last calibration was performed. If this temperature Δ is greater than $\pm 5^{\circ}\text{C}$ since the last mainframe calibration, then you must perform a plug-in module calibration to achieve the specified dc accuracy.

Offset zero

The Offset Zero function performs a quick offset calibration on the optical channel. Since the primary source of calibration error on the optical channel is offset drift, this function is useful:

after the plug-in module vertical calibration described in Chapter 3 has been performed,

and

if the plug-in module has not been removed and reinstalled.

Performing an Offset Zero calibration is much faster than performing a complete vertical calibration.

Key Path

Channel **Calibrate** **Offset zero**

O/E cal

The plug-in module is provided with factory optical calibrations at 1310 nm and 1550 nm. The O/E Calibration function allows you to calibrate the instrument for use at one additional user-defined wavelength between 1200 nm and 1600 nm. This calibration does not affect the factory calibrations.

Calibrate probe Connect a voltage probe to the plug-in and then press:

Calibrate probe

The analyzer calibrates to the tip of the probe by setting the probe attenuation to the actual attenuation ratio of the probe. The analyzer also automatically compensates for any offset the probe may introduce. The CAL signal is internally routed to the probe tip for HP probes.

Key Path

Channel **Calibrate** **Calibrate probe**

Channel Setup Menu



Calibration Overview

Calibration Overview

What you'll find in this chapter

Factory Calibrations
User Calibrations—Optical and Electrical
Complete Calibration

This chapter describes the calibration of the mainframe and the plug-in modules. It is intended to give you, or the calibration laboratory personnel, an understanding of the various calibration procedures available, and how they were intended to be used. There is a description of the calibration menu included in the manuals provided with the plug-in modules and probes.

Proper calibration is critical to measurement accuracy and repeatability. The HP 54750A/83480A and their associated modules and accessories require that both factory and user calibrations be implemented at the recommended intervals in order to perform measurements at their published specifications.

This chapter is divided into three sections. The first section describes factory calibrations. A factory calibration consists of verifying instrument performance to all specifications. If an instrument fails to meet specifications, adjustment or repair may be necessary. For most users, this will mean shipping the instrument back to an authorized service center. Some users may purchase the required instrumentation and perform the factory timebase calibrations themselves using the optional *HP 83480A, 54750A Service Guide*.

The second part of the chapter addresses calibrations that are routinely performed by the end user. Subsections in each of the two main sections discuss the individual calibrations. In addition, there will be summary tables at the end of each of these sections summarizing the main areas addressed. The third part of the manual consists of a complete calibration summary table at the end of the chapter. Both factory and user calibrations must be

performed regularly in order to ensure proper measurement accuracy and repeatability.

CAUTION

The input circuits can be damaged by electrostatic discharge (ESD). Avoid applying static discharges to the front-panel input connectors. Before connecting a coaxial cable to the connectors, momentarily short the center and outer connectors of the cable together. Avoid touching the front panel input connectors without first touching the frame of the instrument. Be sure that the instrument is properly earth-grounded to prevent buildup of static charge. It is strongly recommended that an antistatic mat and wristband be used when connecting to electrical channel inputs, particularly TDR inputs.

Calibration interval

HP recommends that the factory calibration be performed on a periodic basis. HP designs instruments to meet specifications over the recommended calibration interval provided that the instrument is operated within the specified operating environment. To maintain specifications, periodic recalibrations are necessary. We recommend that the plug-in module be calibrated at an HP service facility every 12 months. Users are encouraged to adjust the calibration cycle based on their particular operating environment or measurement accuracy needs.

Required warm-up time

The instrument requires a 1 hour warm-up period before any of the calibrations mentioned in this chapter are performed. It is not enough for the instrument to be in the standby setting. It must be turned on and running for the entire hour.

Remote operation

Remote programming commands for calibrations are included in the *HP 83480A/HP 54750A Programming's Guide*. Performing calibrations remotely is slightly different than the operation of front-panel calibrations.

Factory Calibrations

The following calibrations are performed at the factory:

Mainframe Calibration
O/E Factory Wavelength Calibration

Table 3-1. Factory Calibration Summary

Calibration	What is calibrated	Measurements Affected	Recommended Interval	Softkey Path
Mainframe Calibration	Accuracy and continuity of the timescale	Channels affected: optical & electrical. All time base measurements such as rise time, fall time, eye width, and jitter.	Annually at HP service center or if operating temp has changed and remains 5°C or more from calibration temperature. See service manual.	Utility Calibrate Calibrate frame
O/E Factory Wavelength Calibration	The photodetector responsivity	Channels affected: optical. Amplitude accuracy of all optical channel measurements. Optical power meter accuracy.	Annual factory re-calibration of standard wavelengths.	Not user accessible. ¹

¹ Refer to "O/E User-Wavelength Calibration" in this chapter.

Mainframe Calibration

Mainframe calibration affects both optical and electrical measurements. Mainframe calibration improves timebase accuracy. All timebase measurements such as rise time, fall time, eye width, jitter, and so forth are affected by the timebase accuracy.

The calibration factors are stored in the nonvolatile RAM of the instrument. There is a switch on the back panel of the instrument that allows the mainframe calibration to be protected or unprotected. Next to the switch there is a drawing that shows each switch's function and protected position. Refer to the optional *HP 83480A, 54750A Service Guide* for more details about the mainframe calibration, and the position of the rear-panel memory protect switches.

CAUTION

To prevent access to the mainframe calibration switch, place a sticker over the access hole to this switch.

CAUTION

Do not attempt a Mainframe calibration without consulting the *HP 83480A, 54750A Service Guide*.

A mainframe calibration should be performed on a periodic basis, annually, or when the ambient operating temperature has changed by and remains 5°C different than the operating temperature at which the last mainframe calibration was performed. To see how much the operating temperature has changed since the last mainframe calibration and the date of the last mainframe calibration, check the Calibration status by pressing the following key sequence: **Utility**, **Calibrate**, and then **Cal status on**.

The temperature change is displayed at the top of the display as shown in the following figure.

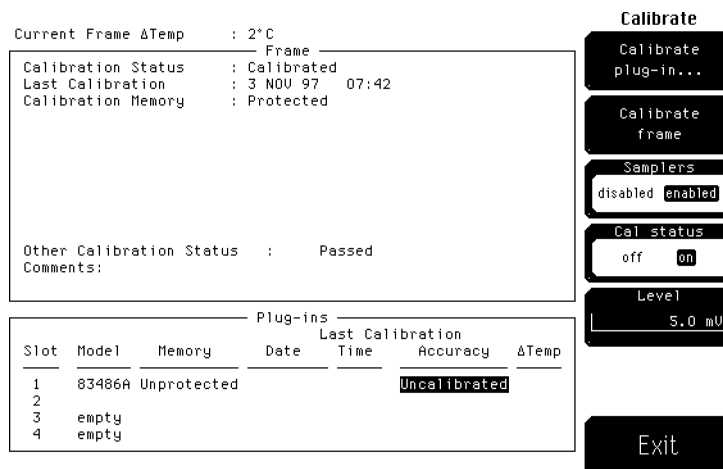

Figure 3-1. Current Frame Δ Temp condition

Factory Calibrations

If the **Current Frame ΔTemp** listing is greater than $\pm 5^{\circ}\text{C}$, then the mainframe should either be calibrated at the current operating temperature or be placed in an ambient air temperature that is within 5°C of the temperature of the current calibration.

O/E Factory Wavelength Calibration

Optical/electrical (O/E) factory wavelength calibration, compensates for the photodetector responsivity. The accuracy of all optical channel measurements is dependent on proper O/E calibration. O/E calibrations should be performed annually. Most customers return their optical plug-ins to an authorized HP service center for this calibration at the same time they are having their mainframes re-calibrated.

The HP 83480-series optical modules have one or two standard wavelengths (850 nm or 1310/1550 nm). The O/E Calibration function allows you to calibrate the instrument for use at one additional user-defined wavelength. This calibration does not affect the factory calibrations. See the following section on User Calibrations for additional information on this procedure.

User Calibrations—Optical and Electrical

The following calibrations can be performed by the user:

- O/E User Wavelength Calibration
- Plug-in Module Vertical Calibration
- Offset Zero Calibration
- Dark Calibration
- Probe Calibration
- Channel Skew
- External Scale

Electrical channels have calibration procedures for:

- adjusting timebase skew, for matching propagation delay between channels, probes, cables, and so forth
- using external probes

Optical channels have calibration procedures for:

- adjusting timebase skew
- monitoring and adjusting internal offsets
- performing a user-defined O/E responsivity adjustment

CAUTION

The input circuits can be damaged by electrostatic discharge (ESD). Avoid applying static discharges to the front panel input connectors. Before connecting a coaxial cable to the connectors, momentarily short the center and outer connectors of the cable together. Avoid touching the front panel input connectors without first touching the frame of the instrument. Be sure the instrument is properly earth-grounded to prevent buildup of static charge. An antistatic mat and wristband are strongly recommended, particularly when working with TDR modules.

User Calibrations—Optical and Electrical

Table 3-2. Optical and Electrical Channel User Calibration Summary

Calibration	What is calibrated	Measurements Affected	Recommended Interval	Key Path
O/E User Wavelength Calibration	The photodetector responsivity	Channels affected: optical. All optical channel measurements at user wavelengths.	Annual re-calibration of user defined non-factory wavelengths	Optical Channel Setup Calibrate O/E Cal
Plug-in Vertical Calibration	Vertical offset and vertical scale accuracy for both electrical and optical channels.	Channels affected: optical & electrical. Any optical or electrical vertical measurements such as $V_{p\ to\ p}$, eye height, extinction ratio, and the optical power meter	Perform after any power cycle or once every 10 hours during continuous use or if operating temperature changes by more than 2°C.	Utility Calibrate Calibrate Plug-in
Offset Zero Calibration	Vertical offset is calibrated for the optical channel only. This calibration doesn't include vertical scale accuracy.	Channels affected: optical. Any optical vertical measurements including: $V_{p\ to\ p}$, eye height, and extinction ratio.	Perform a plug-in vertical calibration in order to meet published specifications. Because the offset zero calibration performs only the offset portion of the plug-in vertical calibration, it should only be used before fast non-critical measurements.	Optical Channel Setup Calibrate Offset 0
Dark Calibration	Dark calibration measures the channel offset signal without any light present and this value is used in the extinction ratio algorithm.	Channels affected: optical & electrical. Extinction ratio.	Before extinction ratio measurements if the vertical scale or offset has changed since the last dark calibration or after a plug-in vertical calibration is performed.	Shift , Meas eye Extinction ratio Dark Cal

Table 3-3. Miscellaneous User Calibration Summary

Calibration	What is calibrated	Measurements Affected	Recommended Interval	Key Path
Probe calibration	Probe Attenuation	Channels affected: electrical. Any electrical measurement taken with the probe	Whenever a probe is connected	Electrical Channel Setup Calibrate Calibrate probe
Channel Skew	Calibrates out the small differences in delay between channels. Useful for looking at timing differences between channels	Channels affected: optical & electrical. Multiple channel measurements, such as Differential TDR	Before multiple channel measurements when measuring timing differences between channels.	Channel Setup Calibrate Skew
External Scale	Compensates for gain or loss associated with external devices calibrates vertical scale to external device	Channels affected: optical & electrical. Any measurement taken through an external device component or transducer	Whenever using external devices component or transducer	Channel Setup External Scale

O/E User-Wavelength Calibration

This optional optical/electrical (O/E) calibration is for optical measurements only. It compensates for the photodetector's responsivity. The vertical accuracy of all optical channel user wavelength measurements is dependent on proper O/E user wavelength calibration. O/E user-wavelength calibrations should be performed annually or whenever a new wavelength is being measured. To perform a O/E user-wavelength calibration, a CW optical source with a known optical output power level is required. Refer to the specifications for the plug-in module for the acceptable power level ranges.

User Calibrations—Optical and Electrical**NOTE**

The optical channel calibration accuracy is heavily dependent on the accuracy to which you know the optical source power. For best results, measure the optical source power with an optical power meter such as the HP 8153A and use precision optical connectors. In addition, proper connector cleaning procedures are essential to obtaining an accurate calibration.

**To perform an O/E
user-wavelength
calibration**

1. Press the plug-in module's front-panel optical channel **SETUP** key.
2. Press **Calibrate**, and then **O/E cal**.
3. Input the correct wavelength, and follow the instructions on the screen.

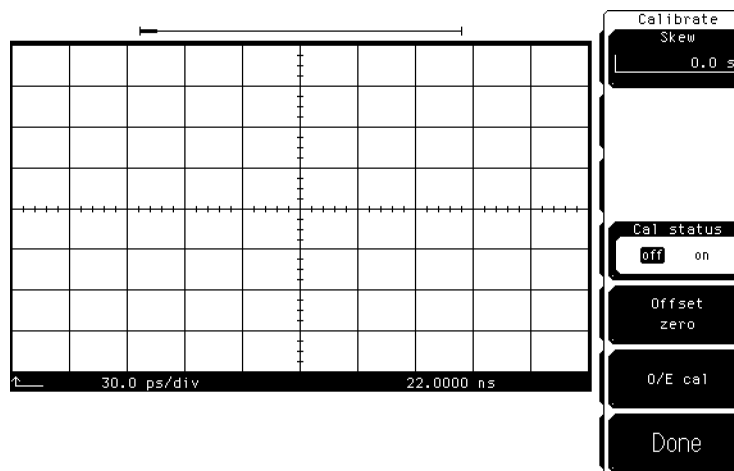

Figure 3-2. Plug-in calibration menu

**To use an O/E
user-wavelength
calibration**

1. Press the plug-in module's front-panel optical channel **SETUP** key.
2. Press **Bandwidth/wavelength** and then **Wavelength**.
3. Press **Usr wavelength** and then **Enter**.

Plug-in Module Vertical Calibration

The plug-in module vertical calibration is for both optical and electrical measurements. It allows the instrument to establish the calibration factors for a specific plug-in when the plug-in is installed in the mainframe. The plug-in calibration factors are valid only for the specific mainframe slot in which it was calibrated. The plug-in vertical calibration establishes vertical accuracy.

A plug-in vertical calibration should be done if:

- The mainframe has cycled power.
- The plug-in has been repaired, reprogrammed, or removed from the mainframe.
- The instrument's operating temperature has changed and remains more than 5°C from the temperature at which the Plug-in calibration was performed.

To obtain the best measurement results, it is recommended that a user vertical calibration be performed after every 10 hours of continuous use or if the temperature has changed by greater than 2°C from the previous vertical calibration.

**To view the
temperature change**

This procedure displays the temperature change that the instrument has undergone since the last Plug-in Vertical Calibration.

1. Press the front-panel channel **SETUP** key.
2. Press **Calibrate** and then **Cal status on**.

The current plug-in Δ Temp value is listed for each installed module.

To perform a plug-in module vertical calibration

1. Remove any front-panel connections from electrical channels.
2. Cover the optical inputs for the optical channels.
3. Press **Utility**, **Calibrate. . .**, and then **Calibrate plug-in. . .**.
4. Select the plug-in module to be calibrated, press **1 and 2** or **3 and 4**.
5. Press **Start cal** to start the calibration.
6. Follow the on-screen instructions.

No additional equipment is required to perform a plug-in vertical calibration. Reference signals are both generated and routed internally, for the optical and electrical channels. If you are prompted to connect the calibrator output to the electrical channel during an optical vertical calibration, then the factory O/E calibration has been lost. The module must then be returned to HP for calibration.

Offset Zero Calibration

The offset zero calibration performs a quick offset calibration on the optical channel for optical measurements. Since the primary source of calibration error on the optical channel is offset drift, this function is useful between the plug-in module vertical calibrations if the plug-in module has not been removed or reinstalled and the operating temperature has not changed more than $\pm 5^{\circ}\text{C}$. In order to ensure that instrument specifications are met, perform the plug-in vertical calibration.

Performing an offset zero calibration is much faster than performing a complete vertical calibration. For critical measurements where offset measurement uncertainty is important to consider, perform an offset zero calibration between module vertical calibrations. Perform an offset zero calibration if the vertical scale or offset changes.

To initiate an offset calibration

1. Disconnect all inputs from the module being calibrated.
2. Cover all optical inputs.
3. Press the plug-in module's front-panel optical channel **SETUP** key.
4. Press **Calibrate** and then **Offset zero**.

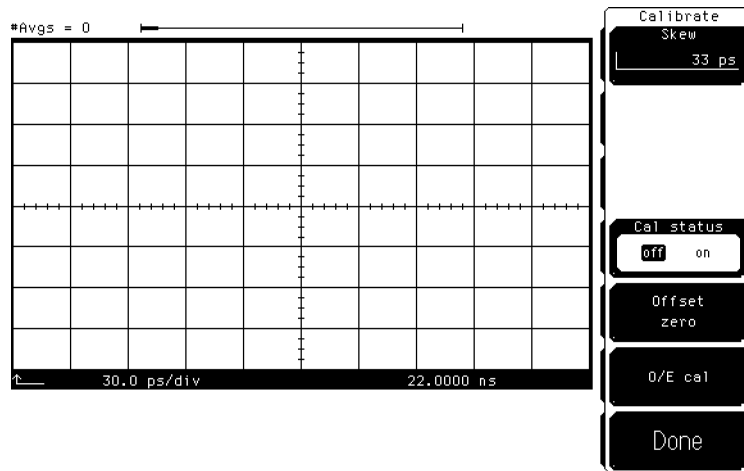

Figure 3-3. Offset Zero Calibration

Dark Calibration

The dark calibration is for optical measurements, or electrical measurements if an external O/E is being used. This calibration measures the optical channel offset signal when there isn't any light present and then uses this information in performing extinction ratio measurements. Dark calibrations should be done for the following conditions:

- Before any critical extinction ratio measurements are made
- After a plug-in vertical calibration
- If a module has been removed
- If the mainframe power has been cycled
- If extinction ratio measurements are being made after the vertical scale or the offset has changed.

If the line power has been cycled, the dark calibration invokes either the offset zero calibration or plug-in vertical calibration as needed. This increases the time required for the dark calibration to complete. The **Dark cal** softkey is located within the Extinction ratio menu.

To initiate a dark calibration

1. Press the **Display** key. Press the **Color grade** softkey, and set its setting to **on**.

Color grade must be enabled to perform an extinction ratio measurement and a Dark calibration. In addition, the dark level (amplitude when there is no signal present) must be on the screen to perform a Dark calibration.

2. Press the blue shift key, and then the **Meas eye** softkey which is located beneath the display.
3. Press **Extinction ratio ...** and then **Dark cal**.

Disconnect all inputs from the module, including the trigger signal, and block any ambient light to the photodetector with a connector plug. Follow the instructions on the screen.

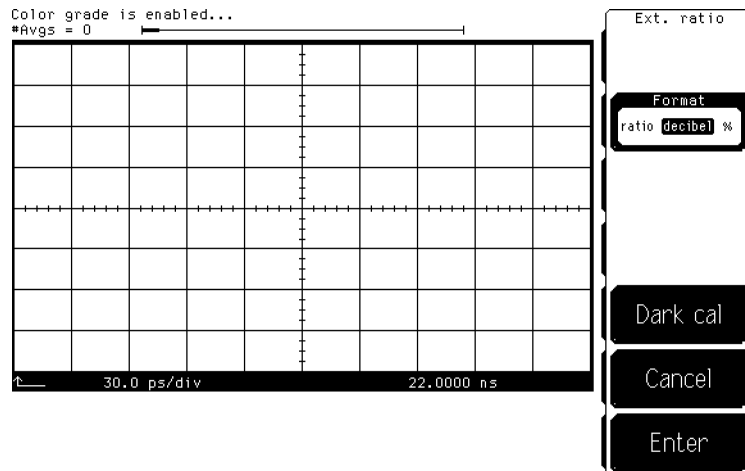

Figure 3-4. Dark calibration menu

Channel Skew Calibration

This calibration affects both optical and electrical measurements. The skew calibration changes the horizontal position of a waveform on the display. The skew calibration has a range of approximately 100 μ s. You can use skew to compensate for the differences in cable or probe lengths. It also allows you to place the trigger edge at the center of the display when you are using a power splitter connected between the channel and trigger inputs. Another use for skew is when you are comparing two waveforms that have a timing difference. If you are interested in comparing the shapes of two waveforms rather than the actual timing difference, you can use skew to overlay one waveform on top of the other waveform.

To skew two channels

1. Turn both channels on and overlay the signals vertically.
2. Expand the time base so that the rising edges are at about a 45° angle.
3. Press the plug-in module's front-panel channel **SETUP** key.
4. Press **Calibrate** and then **Skew**.
5. Adjust the skew on one of the channels so that the rising edges overlap at the 50% points.

Probe Calibration

Probe calibration applies to electrical measurements only. For active probes such as the HP 54701A, which the instrument can identify through the probe power connector, the instrument automatically adjusts the channel vertical scale factors to the probe's nominal attenuation, even if a probe calibration is not performed.

For passive probes or non-identified probes, the instrument adjusts the vertical scale factors only if a probe calibration is performed. Probe calibration allows the instrument to establish the gain and offset of specific probes that are connected to a channel of the instrument, and then apply those factors to the calibration of that channel.

The analyzer calibrates to the tip of the probe by setting the probe attenuation to the actual attenuation ratio of the probe. The CAL signal is internally routed to the probe tip for HP active probes.

The mainframe's CAL signal is a voltage source, therefore you can let the instrument compensate for the actual characteristics of your probe by letting the instrument calibrate to the tip of the probe. The instrument automatically calibrates to the tip of the probe, sets the probe attenuation, and compensates for any probe offset.

If you do not perform a probe calibration but want to use a passive probe, enter the attenuation factor using the following steps:

1. Press the plug-in module's front-panel channel **SETUP** key.

2. Press **External scale** and then **Attenuation**.

You can use the probe calibration to calibrate any network, including probes or cable assemblies. The instrument calibrates the voltage at the tip of the probe or the cable input.

To calibrate an HP identifiable probe

1. Press the plug-in module's front-panel-channel **SETUP** key.
2. Press **Calibrate** and then **Calibrate Probe**.

To calibrate a non-identifiable probe

1. Connect the voltage probe to the plug-in.
2. Attach the probe tip to the CAL hook that is located near the floppy disk drive.
3. Press the plug-in module's front-panel channel **SETUP** key.
4. Press **Calibrate** and then **Calibrate probe**.

If the probe being calibrated has an attenuation factor that allows the instrument to adjust the gain (in hardware) to produce even steps in the vertical scale factors, the instrument will do so. Typically, probes have standard attenuation factors such as divide by 10, divide by 20, or divide by 100.

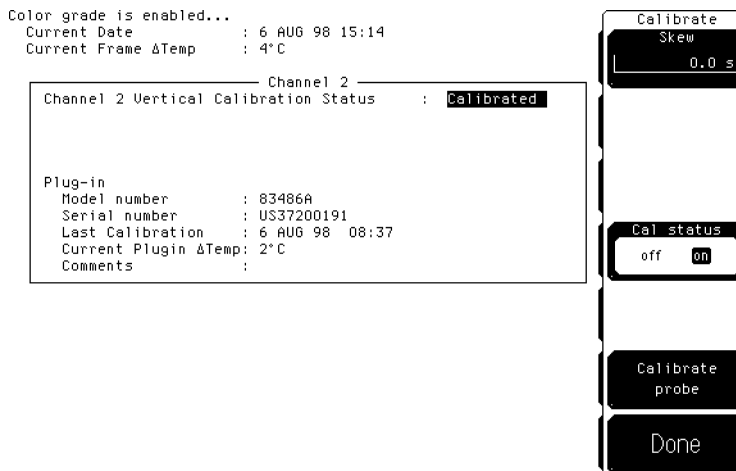

Figure 3-5. Electrical Channel Calibrate Menu

To calibrate other devices

The information in this section applies to both optical and electrical measurements. Since the mainframe's CAL signal is a voltage source, it cannot be used to calibrate to the probe tip when the units are set to Ampere, Watt, or Unknown. Instead, set the external gain and external offset to compensate for the actual characteristics of the probe or device. If you do not know the actual characteristics, you can refer to the typical specifications that came with the probe or device.

1. Press the plug-in module's front-panel channel **SETUP** key.
2. Press **External scale**.
3. Press **Atten units** Ratio, **Attenuation** 1:1, and then **Units** Ampere (Volt, Watt, or Unknown).
4. Press **Ext gain**, and enter the actual gain characteristics of the probe or device.
5. Press **Ext offset**, and enter the offset introduced by the probe or device.

External Scale

Both optical and electrical channels have an External scale setting which allows the user to enter in an offset value to compensate for gains or losses not associated with the device under test. This feature is useful for adjusting out the effects of devices such as test fixtures and attenuators so that the reading on the display gives the measurement value associated with only the actual device under test.

To adjust the external scale

1. Press the plug-in module's front-panel channel **SETUP** key.
2. Press **External scale**, and set the **Atten units** to "decibel".
3. Press **Attenuation**, and enter the appropriate values.

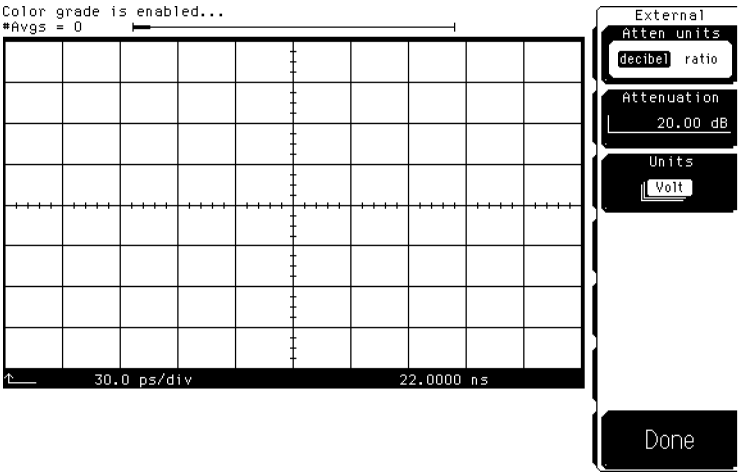

Figure 3-6. External Scale Menu

Complete Calibration Summary

Table 3-4. Complete Calibration Summary

Calibration	What is calibrated	Measurements Affected	Recommended Interval	Key Path
Mainframe Calibration	Accuracy and continuity of the timescale	Channels affected: optical & electrical. All time base measurements such as rise time, fall time, eye width, and jitter.	Annually at HP service center or if operating temp has changed and remains 5°C or more from calibration temperature. See service manual.	Utility Calibrate Calibrate frame
O/E Factory Wavelength Calibration	The photodetector responsivity	Channels affected: optical. Amplitude accuracy of all optical channel measurements. Optical power meter accuracy.	Annual factory re-calibration of standard wavelengths.	Not user accessible. ¹
O/E User Wavelength Calibration	The photodetector responsivity	Channels affected: optical. All optical channel measurements at user wavelengths.	Annual re-calibration of user defined non-factory wavelengths	Optical Channel Setup Calibrate O/E Cal
Plug-in Vertical Calibration	Vertical offset and vertical scale accuracy for both electrical and optical channels.	Channels affected: optical & electrical. Any optical or electrical vertical measurements such as V_p to p , eye height, extinction ratio, and the optical power meter	Perform after any power cycle or once every 10 hours during continuous use or if operating temperature changes by more than 2°C.	Utility Calibrate Calibrate Plug-in

¹ Refer to "O/E User-Wavelength Calibration" in this chapter.

Table 3-4. Complete Calibration Summary (continued)

Calibration	What is calibrated	Measurements Affected	Recommended Interval	Key Path
Offset Zero Calibration	Vertical offset is calibrated for the optical channel only. This calibration doesn't include vertical scale accuracy.	Channels affected: optical. Any optical vertical measurements including: $V_{p \text{ to } p}$, eye height, and extinction ratio.	Perform a plug-in vertical calibration in order to meet published specifications. Because the offset zero calibration performs only the offset portion of the plug-in vertical calibration, it should only be used before fast non-critical measurements.	Optical Channel Setup Calibrate Offset 0
Dark Calibration	Dark calibration measures the channel offset signal without any light present and this value is used in the extinction ratio algorithm.	Channels affected: optical & electrical. Extinction ratio.	Before extinction ratio measurements if the vertical scale or offset has changed since the last dark calibration or after a plug-in vertical calibration is performed.	Shift , Meas eye Extinction ratio Dark Cal
Probe calibration	Probe Attenuation	Channels affected: electrical. Any electrical measurement taken with the probe	Whenever a probe is connected	Electrical Channel Setup Calibrate Calibrate probe
Channel Skew	Calibrates out the small differences in delay between channels. Useful for looking at timing differences between channels	Channels affected: optical & electrical. Multiple channel measurements, such as Differential TDR	Before multiple channel measurements when measuring timing differences between channels.	Channel Setup Calibrate Skew
External Scale	Compensates for gain or loss associated with external devices calibrates vertical scale to external device	Channels affected: optical & electrical. Any measurement taken through an external device component or transducer	Whenever using external devices component or transducer	Channel Setup External Scale

Calibration Overview

Specifications and
Regulatory Information

Specifications and Regulatory Information

This chapter lists the system specifications and characteristics of the HP 83485A/B optical/electrical plug-in module when it is combined with either the HP 83480A or HP 54750A mainframes. The specifications and characteristics for the mainframe are in the *HP 83480A, 54750A User's Guide*. Specifications apply over the temperature range +15° C to +35° C (unless otherwise noted) after the instrument's temperature has been stabilized after 60 minutes of continuous operation.

In addition, you'll find a declaration relating to regulatory information.

Specifications

Specifications described warranted performance. Unless otherwise noted, corrected limits are given when specifications are subject to minimization with error-correction routines.

Characteristics

Characteristics provide useful, nonwarranted, information about the functions and performance of the instrument. Characteristics are printed in italics.

Calibration cycle

HP designs instruments to meet specifications over the recommended calibration interval provided that the instrument is operated within the specified operating environment. To maintain specifications, periodic recalibrations are necessary. We recommend that the plug-in module be calibrated at an HP service facility every 12 months. Users are encouraged to adjust the calibration cycle based on their particular operating environment or measurement accuracy needs.

Specifications

The following are specifications used to test the HP 83485A/B plug-in module. Specifications are valid after a 1 hour warm-up period. See the *HP 54701A Active Probe Service Guide* for complete probe specifications.

Vertical specifications

HP 83485A Electrical Channel Vertical Specifications

Bandwidth —3 dB on electrical or optical channel	dc to 12.4 or 20 GHz, user selectable
dc Accuracy—single marker ¹	
12.4 GHz bandwidth	±0.4% of full scale ±2 mV ±1.5% reading — channel offset ± 2%/°C ΔT _{ca1} ² reading — 0.4%/hr ΔTime ³ reading
20 GHz	±0.4% of full scale ±2 mV ±3% reading — channel offset ± 2%/°C ΔT _{ca1} ² reading — 0.4%/hr ΔTime ³ reading
dc Difference—two marker accuracy on same channel ¹	
12.4 GHz	±0.8% of full scale ±1.5% of delta marker reading ± 2%/°C ΔT _{ca1} ² reading — 0.4%/hr ΔTime ³ reading
20 GHz	±0.8% of full scale ±3% of delta marker reading ± 2%/°C ΔT _{ca1} ² reading — 0.4%/hr ΔTime ³ reading

¹ It is recommended that a user vertical calibration be performed after every 10 hours of continuous use or if the temperature has changed by greater than 2°C from the previous vertical calibration.

² Where ΔT_{ca1} represents the temperature change in Celsius from the last user vertical calibration. Note that the temperature term goes to zero upon execution of a vertical calibration.

³ Where ΔTime represents the time since the last user vertical calibration. The uncertainty due to time typically stabilizes after 24 hours. This term goes to zero upon execution of a vertical calibration.

Specifications**HP 83485A Electrical Channel Vertical Specifications (continued)**

<i>Transition Time (10%–90%) characteristic, calculated from $T = 0.35/BW$, electrical</i>	
12.4 GHz	28.2 ps
20 GHz	17.5 ps
Maximum RMS Noise	
12.4 GHz	0.5 mV 0.25 mV typical
20 GHz	1.0 mV 0.5 mV typical
Scale Factor	full scale is eight divisions
Minimum	1 mV/div
Maximum	100 mV/div
dc Offset Range	± 500 mV
Nominal Input Impedance	50 Ω
Connectors	3.5mm m , channel and trigger
Input Reflection/Return Loss	$\leq 5\%$ for 30 ps rise time
Number of Channels	1
Dynamic Range/Maximum Specified Input Power	± 400 mV relative to channel offset
Maximum Safe Input	$\pm 2V$ + peak ac +16 dBm

HP 83485A Optical Channel Vertical Specifications

Bandwidth —3 dB on electrical or optical channel	dc to 12.4 or 20 GHz user selectable
dc Accuracy—single marker ¹	
12.4 GHz, filtered ²	±25 μ W ±2% reading — channel offset ± 2%/°C ΔT_{ca1} ³ reading — 0.4%/hr Δ Time ⁴ reading
20 GHz ²	±25 μ W ±4% reading — channel offset ± 2%/°C ΔT_{ca1} ³ reading — 0.4%/hr Δ Time ⁴ reading
dc Difference—two marker accuracy on same channel ¹	
12.4 GHz, filtered ²	±2% of delta reading ± 2%/°C ΔT_{ca1} ³ reading — 0.4%/hr Δ Time ⁴ reading
20 GHz ²	±4% of delta reading ± 2%/°C ΔT_{ca1} ³ reading — 0.4%/hr Δ Time ⁴ reading
<i>Transition Time (10%–90%) characteristic, calculated from $T=0.48/BW$, optical</i>	
12.4 GHz	40 ps
20 GHz	25 ps
STM-16/OC-48 filter	190 ps
STM-4/OC-12 filter	750 ps
STM-1/OC-3 filter	3 ns
Maximum RMS Noise	
12.4 GHz, filtered	12 μ W 8 μ W typical
20 GHz	25 μ W 15 μ W typical
Scale Factor	full scale is eight divisions
Minimum	20 μ W/div
Maximum	500 μ W/div
dc Offset Range	+1 to –3 mW referenced two divisions below center screen
Connectors	User selected option, 9/125 μ m single mode fiber
Input Reflection/Return Loss	>33 dB for HMS-10/HP interface connector

1 It is recommended that a user vertical calibration be performed after every 10 hours of continuous use or if the temperature has changed by greater than 2°C from the previous vertical calibration.

2 Referenced to average power meter.

3 Where ΔT_{ca1} represents the temperature change in Celsius from the last user vertical calibration. Note that the temperature term goes to zero upon execution of a vertical calibration.

4 Where Δ Time represents the time since the last user vertical calibration. The uncertainty due to time typically stabilizes after 24 hours. This term goes to zero upon execution of a vertical calibration.

Specifications**HP 83485A Optical Channel Vertical Specifications (continued)**

Filtered Response	Measured response conforms to ITU-TS G.957 and GR-253-CORE for STM-16, OC-48 Option 034 or STM-4, OC-12 Option 032 or STM-1, OC-3 Option 030
Calibrated Wavelengths	1310 nm and 1550 nm
Average power Monitor	
Specified Operating Range	−30 dBm to +3 dBm 1 μ W to 2 mW
Factory Calibrated Accuracy 20° C-30° C	$\pm 5\%$ of reading ± 100 nW \pm connector uncertainty
User Calibrated Accuracy ¹ < 5° C temp change	$\pm 2\%$ of reading ± 100 nW \pm power meter accuracy
Number of Channels	1
Dynamic Range/Maximum Specified Input Power	2 mW
Maximum Safe Input	10 mW peak
Wavelength Range	1200–1600 nm

¹ A user calibration can be performed with average optical power levels from 100 to 2000 μ W, however, the instrument optical accuracy specification is only valid for average optical calibration powers from 500 to 2000 μ W.

HP 83485B Electrical Channel Vertical Specifications

Bandwidth −3 dB	dc to 40 GHz, or dc to 18 GHz [user selectable]
dc Accuracy—single voltage marker ¹	
18 GHz	±0.4% of full scale ±2 mV ±1.5% reading − channel offset ± 2%/°C ΔT _{cal} ² reading
40 GHz	±0.4% of full scale ±2 mV ±3% reading − channel offset ± 2%/°C ΔT _{cal} reading ²
<i>Transition Time (10% to 90%, calculated from T=0.35/bandwidth)</i>	≤ 9 ps (40 GHz BW) ≤ 19.5 ps (18 GHz BW)
Maximum RMS Noise	
18 GHz	≤0.5 mV 0.25 mV typical
40 GHz	1.0 mV 0.5 mV typical
Scale Factor full scale is eight divisions	
Minimum	1 mV/div
Maximum	100 mV/div
dc Offset Range	±500 mV
Inputs:	
Dynamic Range	±400 mV relative to channel offset
<i>Maximum Safe Input Voltage</i>	16 dBm peak ac ±2V dc
Nominal Impedance	50 Ω
Reflections	≤5% for 20 ps rise time
Connector	2.4mm [m]

¹ It is recommended that a user vertical calibration be performed after every 10 hours of continuous use or if the temperature has changed by greater than 2°C from the previous vertical calibration.

² Where ΔT_{cal} represents the temperature change in Celsius from the last user vertical calibration. Note that the temperature term goes to zero upon execution of a vertical calibration.

Specifications**HP 83485B Optical Channel Vertical Specifications**

<i>Bandwidth (-3 dB)</i>	<i>dc to 30 GHz</i>
dc Accuracy ¹ Optical channel referenced to average power meter	$\pm 50 \mu\text{W} \pm 4\%$ of reading - channel offset $\pm 2\%/^{\circ}\text{C} \Delta T_{\text{cal}} ^2$ reading
dc Difference ¹ two marker accuracy, same channel, referenced to average power monitor	$\pm 4\%$ of delta reading $\pm 2\%/^{\circ}\text{C} \Delta T_{\text{cal}} ^2$ reading
<i>Transition Time (10% to 90%) characteristic, calculated from $T = 0.48/\text{bandwidth}$, optical</i>	$< 16 \text{ ps}$
Maximum RMS Noise	$< 30 \mu\text{W}$ $< 15 \mu\text{W}$ typical
Scale Factor full scale is eight divisions	
Minimum	$20 \mu\text{W}/\text{div}$
Maximum	$500 \mu\text{W}/\text{div}$
dc Offset Range	+1 mW to -3 mW, referenced to two divisions above bottom of screen
Connector Type	9/125 μm single mode, user selectable connector option
Input Return Loss	30 dB HMS-10/HP connector
Filtered Bandwidth	Fourth or fifth order Bessel-Thomson filter, 3 dB frequency 7.465 GHz
Calibrated Wavelengths	1310 nm and 1550 nm
Average Power Monitor	
Specified Operating Range	-27 dBm to +3 dBm 2 μW to 2 mW
Factory Calibrated Accuracy 20°C to 30°C	$\pm 5\%$ of reading $\pm 100 \text{ nW}$ \pm connector uncertainty
User Calibrated Accuracy $< 5^{\circ}\text{C}$ temp change	$\pm 2\%$ of reading $\pm 100 \text{ nW}$ \pm power-meter uncertainty
<i>Maximum Specified Input Power</i>	<i>2 mW</i>
<i>Maximum Safe Input</i>	<i>10 mW peak</i>
<i>Wavelength Range</i>	<i>1000 to 1600 nm</i>

¹ It is recommended that a user vertical calibration be performed after every 10 hours of continuous use or if the temperature has changed by greater than 2°C from the previous vertical calibration.

² Where ΔT_{cal} represents the temperature change in Celsius from the last user vertical calibration. Note that the temperature term goes to zero upon execution of a vertical calibration.

Environmental specifications

Electrical and Optical Channels	
Temperature	
Operating	15°C to +35°C
Non-operating	−40°C to +70°C
Humidity	
Operating	up to 90% relative humidity non-condensing at $\leq 35^{\circ}\text{C}$
Non-operating	up to 95% relative humidity non-condensing at $\leq 65^{\circ}\text{C}$

Power Requirements

Supplied by mainframe.

Weight

Net	approximately 1.2 kg 2.6 lb.
Shipping	approximately 2.1 kg 4.6 lb.

Characteristics

The following characteristics are typical for the HP 83485A/B optical/electrical plug-in module. See the *HP 54701A Active Probe Service Guide* for complete probe characteristics.

Trigger input characteristics

Electrical and Optical Channels

<i>Nominal Impedance</i>	<i>50 Ω</i>
<i>Input Connector</i>	<i>3.5 mm (m)</i>
<i>Trigger Level Range</i>	<i>± 1 V</i>
<i>Maximum Safe Input Voltage</i>	<i>± 2 Vdc + ac peak (+16 dBm)</i>
<i>Percent Reflection</i>	<i>$\leq 10\%$ for 100 ps rise time</i>

Refer to the *HP 83480A, 54750A User's Guide* for trigger specifications.

Declaration of Conformity

DECLARATION OF CONFORMITY
according to ISO/IEC Guide 22 and EN 45014

Manufacturer's Name: Hewlett-Packard Co.

Manufacturer's Address: 1400 Fountaingrove Parkway
Santa Rosa, California 95403
U.S.A.

Declares that the product:

Product Name: Optical/Electrical plug-in module

Model Numbers: HP 83485A, HP 83485B

Product Options: This declaration covers all options of the above products.

Conforms to the following product specifications:

Safety: IEC 1010-1:1990 + A1 / EN 61010-1:1993
CAN/CSA-C22.2 No. 1010.1-92

EMC: CISPR 11:1990 / EN 55011:1991, Group 1 Class A
IEC 801-2:1991 / EN 50082-1:1992, 4 kV CD, 8 kV AD
IEC 801-3:1984 / EN 50082-1:1992, 3V/m, 27-500 MHz
IEC 801-4:1988 / EN 50082-1:1992, 500 V signal, 1000 V AC

Supplementary Information:

This product was tested in an HP 83480A mainframe.
This product complies with the requirements of the Low Voltage Directive 73/23/EEC and the EMC Directive 89/336/EEC.

Santa Rosa, California

Location

7/17/95 
Date Dixon Browder / Quality Manager

European Contact:

Your local Hewlett-Packard Sales and Service Office or Hewlett-Packard GmbH,
Department ZQ/Standards Europe, Herrenberger Straße 130, D-71034 Boblingen (FAX:
+ 49-7031-14-3143)

Specifications and Regulatory Information



In Case of Difficulty

In Case of Difficulty

What you'll find in this chapter

This chapter provides a list of suggestions for you to follow if the plug-in module fails to operate. A list of messages that may be display is also included.

For complete service information, refer to the optional *HP 83485A/B Service Guide*.

Review the procedure being performed when the problem occurred. Before calling Hewlett-Packard or returning the unit for service, a few minutes spent performing some simple checks may save waiting for your instrument to be repaired.

**If the
mainframe
does not
operate**

Please make the following checks:

- Is the line fuse good?
- Does the line socket have power?
- Is the unit plugged in to the proper ac power source?
- Is the mainframe turned on?
- Is the rear-panel line switch set to on?
- Will the mainframe power up *without* the plug-in module installed?

If the mainframe still does not power up, refer to the optional *HP 83480A, 54750A Service Guide* or return the mainframe to a qualified service department.

If the plug-in does not operate

1. Make the following checks:
 - Is the plug-in module firmly seated in the mainframe slot?
 - Are the knurled screws at the bottom of the plug-in module finger-tight?
 - Is a trigger signal connected to a trigger input?
 - If other equipment, cables, and connectors are being used with the plug-in module are they connected properly and operating correctly?
 - Review the procedure for the test being performed when the problem appeared. Are all the settings correct? Can the problem be reproduced?
 - Are the connectors clean? See “Cleaning Connections for Accurate Measurements” in Chapter 1 for more information about cleaning the connectors.
 2. Perform the following procedures:
 - Make sure the instrument is ready to acquire data by pressing **Run**.
 - Find any signals on the channel inputs by pressing **Autoscale**.
 - See if any signals are present at the channel inputs by pressing:
 - Trigger**
 - Sweep**
 - freerun**
 - After viewing the signal, press **triggered**.
 - Make sure Channel Display is on by pressing:
 - Channel**
 - Display on off on**
 - Make sure the channel offset is adjusted so the waveform is not clipped off the display.
 - If you are using the plug-in module only as a trigger source, make sure at least one other channel is turned on.
- If all of the channels are turned off, the mainframe will not trigger.

- Make sure the mainframe identifies the plug-in module by pressing:

Utility

System config...

The calibration status of the plug-in modules is listed near the bottom of the display, in the box labeled “**Plug-ins**”. If the model number of the plug-in module is listed next to the appropriate slot number, then the mainframe has identified the plug-in.

If “**~known**” is displayed instead of the model number of the plug-in module, remove and reinsert the plug-in module in the same slot. If “**~known**” is still displayed, then the memory contents of the plug-in module are corrupt. Refer to the optional *HP 83485A/B Service Guide* or contact a qualified service department.

If all of the above steps check out okay, and the plug-in module still does not operate properly, then the problem is beyond the scope of this book. Refer to the optional *HP 83485A/B Service Guide* or return the plug-in module to a qualified service department.

Error Messages

The following error messages are for the plug-in module. Typically, the error messages indicate there is a problem with either the plug-in or the mainframe.

This section explains what the messages mean and offers a few suggestions that might help resolve the error condition. If the suggestions do not eliminate the error message, then additional troubleshooting is required that is beyond the scope of this book. Refer to the optional *HP 83485A/B Service Guide* and *HP 83480A, 54750A Service Guide* for additional troubleshooting information.

Additional error messages are listed in the *HP 83480A, 54750A User's Guide* for the mainframe.

Memory error occurred in plug-in : Try reinstalling plug-in

The mainframe could not correctly read the contents of the memory in the plug-in.

1. Remove and reinstall the plug-in module.

Each time a plug-in is installed, the mainframe rereads the plug-in module's memory.

2. Verify the plug-in module is firmly seated in the mainframe slot.
3. Verify the knurled screws at the bottom of the plug-in module are finger-tight.
4. Install the plug-in in a different slot in the mainframe.

Busy timeout occurred with plug-in : Try reinstalling plug-in

The mainframe is having trouble communicating with the plug-in module. Make sure there is a good connection between the mainframe and the plug-in module.

1. Remove and reinstall the plug-in module.
2. Verify the plug-in module is firmly seated in the mainframe slot.
3. Verify the knurled screws at the bottom of the plug-in module are finger-tight.
4. Install the plug-in in a different slot in the mainframe.

Communication failure exists at slot _ : Service is required	<p>An illegal hardware state is detected at the mainframe to plug-in module interface of the specified slot.</p> <p>If the slot is empty, there is a mainframe hardware problem. Refer to the <i>HP 83480A, 54750A Service Guide</i>.</p> <p>If a plug-in is installed in the slot, there is a plug-in module hardware problem. Refer to the optional <i>HP 83485A/B Service Guide</i>.</p>
ID error occurred in plug-in _ : Service is required	<p>The information read from the plug-in module's memory does not match the hardware in the plug-in module. This can be caused by a communication problem between the mainframe and the plug-in module. Make sure there is a good connection between the mainframe and the plug-in.</p> <ol style="list-style-type: none">1. Remove and reinstall the plug-in module.2. Verify the plug-in module is firmly seated in the mainframe slot.3. Verify the knurled screws at the bottom of the plug-in module are finger-tight.4. The HP 54750A mainframe does not accept the HP 83485A/B optical/electrical plug-in module. To use the optical plug-in modules, a firmware upgrade must first be installed. Order the HP 83480K communications firmware kit and follow the installation instructions.5. The HP 83480A, 54750A mainframes do not accept plug-in modules designed for use with the HP 54710A, 54720A.
Cal not possible	<p>The power is too low to perform a user O/E calibration.</p>

In Case of Difficulty



Index

Index

- A** accessories
 - connection devices, 1-5
 - optional, 1-5
- accuracy performance, 1-11
- active probe, 2-7
- attenuation
 - range, 2-10
- Attenuation softkey, 2-10
- attenuator
 - scaling, 2-9
- Atten units softkey, 2-9
- automatic measurement, 2-5
- auxiliary power connector, 1-10

- B** Bandwidth key, 2-8
- Bandwidth/Wavelength . . . softkey, 2-7
- Bessel-Thomson filter, 1-2, 2-8

- C** Calibrate probe softkey, 2-15
- Calibrate softkey, 2-11
- calibration
 - external scale, 3-15
 - factory, 3-4
 - mainframe, 3-4
 - O/E, 2-14, 3-6
 - O/E converters, 3-15
 - O/E user wavelength, 3-9
 - offset zero, 2-14, 3-12
 - overview, 3-2
 - plug-in module vertical calibration, 3-11
 - probe, 3-16
 - probes, 3-15
 - skew, 3-15
 - status, 5-5
 - user, 3-7
 - validity, 2-14
 - vertical, 1-11
 - voltage probe, 3-16
- CAL signal, 2-15
- Cal status softkey, 2-13
- channel

- display, 2-5
- electrical, 1-2
- input, 1-10
- optical, 1-2
- scale, 2-10
- setup, 2-2
- Channel 1 Calibration Status message, 2-14
- Channel autoscale softkey, 2-9
- Channel key, 2-2
- characteristics, 4-10
- cleaning
 - adapters, 1-16
 - non-lensed connectors, 1-15
- cleaning fiber-optic connections, 1-13, 1-15
- connection devices, 1-5
- connector care, 1-13
- Current Date message, 2-13
- Current Frame Δ Temp message, 2-13
- customer assistance, v

D decibel calculation, 2-9

- declaration of conformity, 4-10
- description of the plug-in module, 1-2
- digital offset, 2-7
- Display softkey, 2-5

E electrical channel, 1-2

- environmental specifications , 4-9
 - HP 83485A vertical specifications, 4-3
 - HP 83485B specifications, 4-7
 - trigger input characteristics, 4-10
 - weight, 4-9
- environmental specifications , 4-9
- error messages, 5-6-7
- extender cables, 1-12
- external scale calibration, 3-15
- External scale . . . softkey, 2-9
- external trigger
 - input, 1-10
 - level, 1-12
- Ext gain softkey, 2-11
- Ext offset softkey, 2-11

- F** factory calibration, 3-4
 - fiber-optic cables
 - cleaning connections, 1-13
 - inspecting, 1-14
 - front panel overview, 1-10

- H** horizontal waveform, 2-12

- I** index-matching compounds, 1-13
 - index matching gel, 1-13
 - input connector, 1-13
 - inspecting
 - cables, 1-14
 - installing the plug-in module, 1-11

- K** key conventions, 1-6

- M** mainframe calibration, 3-4
 - mainframe troubleshooting, 5-3
 - marker value, 2-10
 - math function, 2-5
 - menu overview, 1-6

- O** O/E calibration, 3-6
 - O/E cal softkey, 2-14
 - O/E converter calibration, 3-15
 - O/E user wavelength calibration, 3-9
 - offset, 2-5-7, 2-10, 2-14
 - Offset softkey, 2-7
 - offset zero calibration, 3-12
 - Offset zero softkey, 2-14
 - optical channel, 1-2, 2-7
 - environmental specifications, 4-9
 - HP 83485A specifications, 4-4
 - HP 83485B specifications, 4-7
 - trigger input characteristics, 4-10
 - vertical specifications, 4-4
 - weight, 4-9
 - optical-to-electrical converter scaling, 2-9
 - optional accessories, 1-5
 - options, 1-4
 - ordering information, 1-4

P plug-in message, 2-14
plug-in module
 description, 1-2
 features, 1-8
 front panel, 1-10
 installation, 1-11
 purpose, 1-8
 specifications, 4-3-9
 troubleshooting, 5-4
 weight, 4-9
plug-in module vertical calibration, 3-11
power level, 2-7
power requirements, 4-9
probe
 attenuation, 2-10, 2-15
 attenuation factor, 2-9
 characteristics, 2-11
 power, 2-7
 power connector, 1-10
probe calibration, 3-15, 3-16
pulse parameter measurements, 2-5

R RF connectors, 1-11

S safety information, iv, 1-12
Scale softkey, 2-6
shifted function keys, 1-6
skew calibration, 3-15
Skew softkey, 2-12
softkey
 menu, 1-10
 overview, 1-6
SONET/SDH filter, 1-2, 2-8
specifications, 4-7
 plug-in module, 4-3-9

T technical assistance, v
temperature change, 2-13-14
trigger
 external, 1-12
 input characteristics, 4-10
 level, 2-10
 source, 2-5
troubleshooting, 5-2-7

- U** Units softkey, 2-6, 2-10
 - user calibrations, 3-7

- V** vertical
 - calibration, 1-11
 - measurement, 2-10
 - scale, 2-5-6, 2-9
 - specifications, 4-3
 - waveform, 2-7
- voltage
 - measurement, 2-10
 - probe, 2-15
- voltage probe calibration, 3-16

- W** warranty information, vii
- wattage measurement, 2-10
- waveform
 - display, 2-5
 - horizontal, 2-12
- Wavelength key, 2-8
- wavelength settings, 2-7
- weight of plug-in module, 4-9